

VERIFICATION AND CONTROL

These GENERAL RULES apply to all types of ISR racing sanctions and all classes unless so noted. All participants, racers and crewmembers are required to be fully aware of these regulations and must abide by them.

The rules for competition are intended only as a guide for the conduct of the sport in a uniform manner from region to region.

Safety rules and guidelines contained herein are of utmost importance. All participants must be concerned with safety and be familiar with these rules and guidelines. However, ISR does not warrant, guarantee or insure safety even if the rules are enforced and/or adhered to. Moreover, each participant in competition has the responsibility to assess the safety aspects of the facilities and conditions and must assume the risk of competition.

MANDATORY EMERGENCY VEHICLE

1. A properly licensed and equipped emergency vehicle (i.e. rescue vehicle or ambulance) must be at the race site to transport injured persons to an appropriate hospital. Said vehicle will be fully equipped to include items such as oxygen, first aid, burn equipment, splints, backboard and stretcher. This vehicle shall have all emergency equipment.

RULE SUPPLEMENTS

1. Rule supplements, additions or corrections shall be announced in the official publication, magazines or newsletter. Upon such an announcement the rule changes become effective and enforceable.
2. Telephonic race rules conference calls will be followed up with an information letter to the affected affiliates.
3. After a rules meeting, any request to reconsider a new rule requires a ¾ majority vote of the rules committee to approve a revote. Then, a ¾ majority is also required to change the rule.

CLASS DIVISIONS

1. All class entries will not discriminate on the basis of sex. Any qualified member may participate in the approved classes offered in any sanctioned event.
2. A snowmobile will be allowed to race in its respective displacement, or designated performance class, and any larger displacement or performance class, except as noted in specific sections.

REGISTRATION AND ENTRY

1. WAIVER FORMS ARE MANDATORY FOR ALL PERSONNEL IN SECURED AREAS (paddock, staging and track).
2. Driver must have registered at race headquarters and signed a waiver before any runs are made (practice or racing). No one, except officially entered drivers may ride or practice on any racecourse on the day of the event.

3. No refunds of entry or other fees will be made at sanctioned events after registration is closed, unless the event is cancelled or rescheduled by a ruling of the Race Director, after which time fees will be returned.
4. Any competitor who pays for race entry or organization membership with a check or credit card is responsible for the payment of all charges should the bank or other institution fail to remit for whatever reason.
5. Drivers who fail to complete payment for entry fees are subject to discipline prescribed by the ISR affiliate. Drivers may be suspended for a period of one year from the date on which the debt is paid.
 - a. If the participant stops payment on check or credit card, participant gives up the right to protest or appeal until full payment is made.
 - b. Participants who pass NSF checks must pay entry and prescribed fees in full before the next race or within 30 days, whichever is sooner.
6. Insurance fees are not refundable.
7. Regional service charges or insurance surcharges are not considered part of entry fee maximums.
8. Gate admission fees for driver and crewmembers will be regulated on a regional basis.
9. The order of events will be regulated on a regional basis.
10. The maximum number of classes a driver can enter per day will be regulated on a regional basis.
11. Any class or event can be eliminated when there are less than two (2) official entries at the close of registration.
12. All participants in events must be fully familiar with the rules and regulations, plus such rules by Race Promoters that may be specifically applied to any event.

DRIVER AND SNOWMOBILE

1. A driver and his snowmobile (chassis and engine) shall be considered a unit and once the class has begun, neither will be substituted. If a driver qualified on a snowmobile, both must be in the same final event of the class and/or event.
2. Engine parts may be replaced during the event, except for the crankcase and crankshaft, which may not be replaced.

SPONSOR IDENTIFICATION

1. Anytime the sanctioning organization or sanctioned event has a sponsorship, all members and promoters must meet sponsorship requirements, as long as drivers' number system is not compromised.
2. Recommended size for any sponsor's required emblem should not exceed sixteen (16) square inches on the front and twenty-four (24) square inches on the back of the driver's uniform.

DRIVER IDENTIFICATION

1. There will be an automatic suspension for drivers who race under another driver's number.
2. **All drivers will wear their issued bib or a facsimile thereof. Drivers will be**

required to keep the snowmobile numbers and bib numbers in a legible condition. Drivers must either wear a bib with their name and number for the event or their number built into the upper body outer garment worn during competition. Some disciplines (IE. Enduro) will require the driver name to be displayed in addition to the driver's number for the event. In all disciplines numbers are to be 8 inches high with a one- inch width. Name letters are to be 2 inches high with a 3/8" width.

SNOWMOBILE IDENTIFICATION

1. The driver's assigned competitive number must be displayed on both sides of snowmobile hood. The number must be a minimum of six (6) inches high, 3/4 inches wide and be displayed in contrasting colors. Numbers must also be displayed on both sides of tunnel, minimum four (4) inches high. These numbers must be displayed on the snowmobile in a permanent manner before being allowed to race (see illustration). (See Sno-cross section for applicable Sno-cross rules.) (Hillclimb)- Drivers will no longer need to display class participation levels on the sled. The driver will need to provide accurate class information to technical inspection staff. Hillclimb sled competition/race numbers may be permanent or displayed on an approved decal and individual numbers must be a minimum of three (3) inches high and two (2) inches wide.

DRIVER'S NUMBER ON SNOWMOBILE

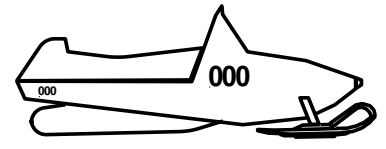

PRE-RACE SAFETY INSPECTION

1. ANY ENTRY IS SUBJECT TO INSPECTION UPON REQUEST BY THE RACE DIRECTOR OR TECHNICAL DIRECTOR.
2. Pre-race safety inspections are mandatory at all races. Passing a pre-race safety inspection is no guarantee that a snowmobile complies with all rules for the event.
3. Only snowmobiles having passed pre-race inspection will be allowed on the racetrack.
4. All aspects of modification are contingent on safety inspection by the Technical Director. The Technical Director may remove any snowmobile from competition that does not meet safety requirements.
5. Damaged or broken safety equipment (not including tether switch) not detected during a race is not grounds for disqualification after completion of that race unless black-flagged during the race in question.

MANDATORY TEARDOWN

1. Regardless of snowmobile equipment passing prior inspections, compliance with the rules must be made at the post-race

inspection.

2. Once a snowmobile has completed registration to race it may be inspected at any time.
3. Tech Director will select the snowmobiles for mandatory teardown and inspection. Drivers will take their snowmobiles directly to Tech after completing the race. The snowmobile must remain in Tech until released by the Tech Director or a designated member of the Tech staff.
4. Driver and/or driver's mechanic will perform teardown to point required by the Technical Director.
5. Any driver not reporting to Tech or refusing teardown will be disqualified.
6. Inspected snowmobiles will not be reassembled by the inspection group.
7. Driver and/or driver's mechanic will be the only two (2) people allowed with the snowmobile in the inspection area.
8. The sanctioning organization assumes no responsibility for impounded snowmobiles.

SEALS

1. Drivers will allow the installation of a seal or seals on the engine and/or body of their racing snowmobiles. To change the seal, mutilate it or try to break it, or re-use it, during the weekend or event where it is installed without the consent of the Race Director, could result in the responsible driver being called before the disciplinary committee for strict discipline. Accidental breakage of the seal must be reported to the Race Director immediately.

PROTESTS

1. All formal protests must be made in writing, by a driver, in competition at the event, from the class in question, on a formal protest form, accompanied by a cash protest fee (protest fee may vary by region or circuit) two hundred and fifty dollars (\$250.00) recommended.
2. When the official protest is made with the fee, the item to be protested must be stated (a general protest will not be accepted), teardown will not be complete until protest is found to be valid or proven unwarranted. If the protest is valid, the fee will be returned to the protester. If the protest is invalid, the fee will be given to the protested snowmobile owner for the inconvenience (to be accomplished before the snowmobiles are released from teardown).
3. There is no need for formal protests in the case of driving infractions during an event. Reports of such alleged infractions should be made to the Race Director, who in turn will request a report from the flagman or assigned official on the course.
4. Race Director has the authority to determine the validity of a protest.
5. No protests will be accepted that refer to a Race/Technical Director's judgement or decision.
6. It shall not be possible to protest or appeal technical inspection equipment, manual /electronic scoring or manual/electronic timing equipment.
7. Protests must be filed within thirty (30) minutes following the completion of the

daily event or within thirty minutes following the official announcement of results for the class in question whichever occurs first.

8. Properly filed protests must be addressed by sanctioning body before finalizing class results.

APPEALS Appeals Process

The following appeals process shall be applicable for all ISR affiliates and will be the binding operational guide and procedure statement for all affiliates effective July 30, 2015. For any Affiliate that has an internal Appeals Process, the process will only apply to operations inside the association or company and will not have any bearing on race rule interpretation, infractions, misconduct or other situations that may arise from race activity.

Technical Infractions

Driver or team are found in non-compliance with the rules concerning fuel, sled construction, specific dimensions, materials used, or components used not conforming to the rules for each specific class, the following will be the procedure.

Tech Director or Race Director determines infraction and makes the appropriate decision considering the gravity of the offence. The Director may:

- a. Verbally warn driver or team.
- b. Disqualify driver from event for the class specified.
- c. Disqualify driver from all events entered in days competition.
- d. Fine driver, if affiliate has a fine process in place in the affiliates bylaws or published operational guide.
- e. Suspend driver or team for season.

On Track Infractions

Race Director determines infraction and makes the appropriate decision considering the gravity of the offence. The Director may:

- a. Verbally warn driver or team.
- b. Disqualify driver from event for the class specified.
- c. Disqualify driver from all events entered in days competition.
- d. Fine driver, if affiliate has a fine process in place in the affiliates bylaws or published operational guide.
- e. Suspend driver or team for season.

If the affected driver feels the decision is not correct, he/she may appeal the decision in the following manner.

1. The Appeal must be presented to the affiliate Race Director in writing using the ISR approved form available from the ISR web site. This form must be presented within 30 minutes of the announcement of the disqualification or penalty. The Appeal must be accepted by the affiliate.

2. The affiliate must within 24 hours convene a meeting of the owner/ management/ officials

of the affiliate and review the offense/ infraction. If the offense is upheld, the driver/team can request a further appeal to ISR and ask for a review by the rules group for the discipline. ISR has 5 days to conduct such review with the rules committee of the specific discipline.

If the Appeal is found valid, all points, money, prizes, etc are returned/ awarded to the driver/team.

3. If the offense is upheld, the Affiliate and the Driver/team must inform ISR of the situation within 24 hours of the alleged infraction. ISR will then, within 5 working days conduct a review of the situation, convene the appropriate rule review group from the proper discipline/aspect and render a decision. The decision of this session is binding and has no further appeal.

Affiliates and Drivers must review the Chain of Custody and submission of components/ fuels/ design concepts presented for the Appeal. If the driver/team does not submit samples, exhibits, photos, etc of the offending component or fuel, the appeal is considered void and the penalty stands. If the Affiliate does not accept and submit samples, exhibits, photos, etc of the offending component or fuel, the appeal is considered void, and the penalty is rescinded, and all prize money, awards and points are returned to the driver/team. There is no appeal of any type to this operational chain of evidence and procedure.

The Operational Guideline and Appeals Forms are found here:

Race Operation Infractions [Click here](#)
Rules Interpretation Issues [Click here](#)
Business Operation Misconduct [Click here](#)

The affected driver/team may ask for a review of a decision or procedure within 30 minutes of the conclusion of the event or race where the infraction is deemed to have occurred.

1. The Appeal must be presented to the affiliate Race Director in writing using the ISR approved form available from the ISR web site. This form must be presented within 30 minutes of the announcement of the disqualification or penalty. The Appeal must be accepted by the affiliate.

2. The affiliate must within 24 hours convene a meeting of the owner/ management/ officials of the affiliate and review the offense/ infraction. If the offense is upheld, the driver/team can request a further appeal to ISR. ISR has 5 days to conduct such review by ISR management and consultants. If upheld the driver/team has no further appeal. If the Affiliate decision is overruled, all points, money and prizes are awarded to the driver. The ISR decision is binding and has no further appeal, from Driver/Team or Affiliate.

NOTICE

Driver infractions/ disqualifications in a drag racing, oval racing, enduro racing, cross country racing, water cross racing, and speed run racing events will be forwarded to all ISR affiliates.

NOTICE

Drivers, promoters or any personnel affiliated with ISR snowmobile events who are banned from racing or subject to other major penalties by one affiliate, having completed the hearing process, the decision shall be honored by all ISR affiliates.

PRIZES AND AWARDS

1. All prizes, awards and paybacks shall be presented to the official winners or their appointed representatives at the close of the event, unless specifically advertised otherwise as to the time and place of awards.
2. Drivers will not be required to attend award banquets, parties, ceremonies, etc., to receive prizes, awards or pay-backs, although they are encouraged to cooperate as a courtesy to the promoter.

PIT AND PADDOCK/STAGING AREA

1. Reasonable speeds will be observed in the pit and paddock area. All pit areas are caution zones where utmost in driver awareness is required.
2. Hot pit and staging areas are limited to drivers preparing to race and their pit crewmembers. Minimum age for pit crewmembers in these areas is 14 years old. All persons in these areas must have signed a release and waiver for the event.
3. There is no minimum age for people in paddock, pit parking and cold pit areas. It is recommended that people in these areas be required to sign a release and waiver.

TESTING, TUNE-UP, WARM-UP & PRACTICE

1. It is highly recommended that testing areas (separate from the racetrack) not be used.
2. Testing of the engine and/or snowmobile must be done in a designated area only. Driver must consult with Race Director to determine proper testing areas at each event.
3. Testing area must be a suitable course or area, completely free of obstructions, which provides adequate and safe run-off areas, so competitor may slow down and exit safely.
4. Fences or squared off banks shall not be permitted at the end of the testing area.
5. Officials must provide proper supervision of the testing areas as well as adequate crowd control to prevent spectators or other persons from moving onto the area.

SUPPORT VEHICLES

1. No unauthorized motorized vehicles will be allowed in the pit or staging area. Snowmobiles must return under their own power. Only disabled snowmobiles may be towed from the track.

TEMPORARY SHELTERS

1. Competitors shall not utilize temporary shelters such as tents, sunshades or other structures made from flammable materials. Such equipment shall have proof of flame resistance testing affixed for inspection by race officials.

ANIMALS

1. No aggressive animals will be allowed at

the race site.

DRIVER PROTECTIVE EQUIPMENT

It is the responsibility of the racer to select protective equipment that will conform to ISR guidelines and provide adequate protection. Even though race rules committees and ISR develop guidelines, ISR does not endorse or guarantee specific products or manufacturers of protective equipment. Racers must rely on their own judgment in the selection of helmets and other apparel for protection and durability.

1. Regardless of driver apparel passing prior inspections, compliance with the rules must be made at post-race inspections. Full coverage helmets are mandatory. Helmets will be full protective coverage and carry the 2015 Snell Foundation Approval Code. Helmets carrying European Standard ECE 22.05 are also approved. This is also mandatory in the tune-up area. The helmet must be securely fastened at all times. SnowCross: Any snowmobile operator under the age of 18, must wear a helmet anytime a snowmobile is operated anywhere at the racing facility.
2. Enclosed cockpit sled drivers must use an automotive certified helmet meeting Snell SA specification.
3. (Oval, Cross Country, Enduro) It is mandatory that the driver's helmet must be a minimum of seventy five percent (75%) international or blaze orange.
4. (Sno-Cross /Watercross): The helmet must be predominantly blaze or international orange in color. More than 50% of its entire outer surface including the visor must be orange. There is a mandatory 6" x 6" area located lower center in the middle of the back of the helmet that must be solid Orange. A template measuring 2 inches by 3 inches placed anywhere on the helmet must contact orange color except on a 4" X 6" spot on the left and right-hand side of the helmet. [Click here to see a Diagram](#). On a typical snocross helmet there should be at least 144 square inches (12 X 12 inches) of orange.

For **Cross Country**, Enduro, Ice Lemans, Oval Sprint, Vintage oval, and Snow Cross: At least one hundred forty-four (144) square inches of visible area on both the driver's front and back (upper body) will be international or blaze orange in color at all events. Jackets / Pullovers / Jerseys will be teched lying flat on the ground front and back. This is strongly recommended in all other types of racing. This does not apply in Enclosed Cockpit classes. This does not apply in Enclosed Cockpit or Outlaw 600 classes.

5. Gloves and clothing, along with at least above ankle leather boots are mandatory (above ankle boot must have a minimum of 6 inches of leather above the ankle).

6. Eye protection mandatory; facemasks may be required at the starting line at the discretion of the Race Director. If corrective lenses are required to drive a motor vehicle, the driver will also be required to wear them when racing.
7. Hearing protection is mandatory in all non-stock classes in all types of competition. Recommended for all stock class competition.
8. The use of upper body protection equipment is mandatory, except for enclosed cockpits. The upper body protection must cover all body areas shown in illustration. It will protect the driver in mid-body and back areas and be capable of resisting penetration and dissipating force of impacts while absorbing the shock of most blows. Typical motocross vests do not meet this rule.
9. (Cross Country / Sno Cross) Shoulder pads must be added to upper body protection (see illustration).

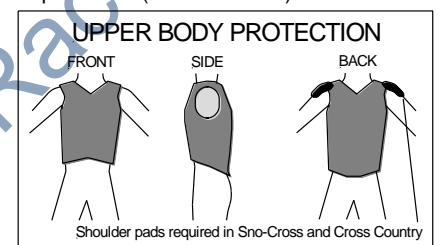

10. Shin and knee guards are mandatory. Shin and knee guards will be worn on both legs. The shin guard must extend from the instep to above the kneecap and be constructed of an impenetrable material.
11. Upper Arm Pads and Elbow pads are highly recommended in all forms of racing.
12. Neck bracing recommended in all forms of racing.

Upper Body Protection That Meets ISR Guidelines [Click Here](#)

Evs [Click Here](#)

Tek Vest [Click Here](#)

Saf-Jak [Click Here](#)

Leatt Adult [Click Here](#)

Leatt Youth [Click Here](#)

HMK Protective Vest [Click Here](#)

13. Leather suits: see specific requirements in various disciplines. (Drag, Oval, Speed Run)

GENERAL COMPETITION

FLAG RULES

1. There shall be a meeting between the flagman and corner flagmen prior to the start of a race so there is a definite understanding concerning the use of the corner flags.
2. Any competitor who does not obey the following rules will be subject to disqualification and/or fine.

GREEN FLAG

1. Start of race or signifies course is clear and race is in progress.

YELLOW FLAG

1. (OVAL) Track corners: signifies there is an additional safety hazard on the track.
2. (SNO-CROSS) A yellow flag indicates an accident or other incident, which may include obstruction of the racetrack.
 - a. Yellow flag zone is that portion of the track from the first yellow flag to a point past the entire incident.
 - b. Drivers must slow down and observe caution while in the yellow flag zone.
 - c. No passing allowed in a yellow flag zone.
 - d. Racing may be resumed after leaving the yellow flag zone.
3. (ENDURO) Flag signifies that there is an additional safety hazard on the racetrack. When a yellow flag comes out, the entire track will be put on yellow. Snowmobiles will form a single line. No racing. Starting Line - The yellow flag signifies caution. After the yellow flag is displayed, competitors must slow down, hold positions and do not pass until the green flag is again displayed or the red flag is given automatically stopping the race. All laps under the yellow flag will be scored as part of the race. All snowmobiles entering the track during yellow must blend into traffic at nearest opening. Under no circumstances is passing permitted under the yellow flag. Team violating this rule will be subject to disqualification, fine and/or loss of laps. When the yellow flag is displayed, all snowmobiles will slow down to thirty-five (35) mph.

RED FLAG

1. The red flag means the race will stop immediately regardless of position of snowmobiles on the track. The red flag will be used if, in the opinion of the Race Director or Chief Starter, the track is unsafe to continue the race. Snowmobiles should be brought to the starting line if possible, using extreme caution. Snowmobiles must not leave the track proper unless directed to do so by the Race Director. (Enduro) While the red flag is displayed, no work or refueling allowed on snowmobiles including those in the pits. Drivers are not to receive assistance of any kind. (SnowCross) Upon seeing the red flag drivers are to stop and then proceed with caution to the starting area.
2. Normal pit activity resumes after the field

begins moving in preparation for restart.

BLACK FLAG

1. On closed course races, should a vital snowmobile component such as clutch guards, hoods, mud flaps, or ski become dislodged or discarded, the starter will display the black flag to the involved driver immediately. A rolled black flag is a warning to a driver that he/she may have an equipment failure or that he/she may have committed a driving infraction.
2. (Oval) Consultation flag-leave course immediately and report to the Race Director, (Snowcross) report to starter. This does not necessarily mean disqualification; however, failure to obey the black flag could result in disqualification, suspension or fine. The black flag will have a one (1) inch wide white border and a one (1) inch wide white cross through the center of the flag. On closed course races, should a vital snowmobile component such as clutch guards, hoods, mud flaps, or ski become dislodged or discarded, the starter must display the black flag to the involved driver immediately.
3. (Sno-Cross) During a race if a driver is shown a furred black flag the driver must: Stop on the next lap at the start/finish line to consult with the flagman. Driver should stop on the inside of the track in a safe manner, close to the flagman. Driver may be allowed to re-enter the race at the discretion of the flagman.
4. (Enduro) Consultation flag - leave course immediately and report to the Race Director. Failure to obey the black flag after running two (2) laps under the black flag loss of laps will result.

WHITE FLAG

1. When displayed, drivers have started their last lap.
2. WHITE FLAG- (Oval) White Flag shall have a green two (2) inch border around it.

CHECKERED FLAG

1. When the checkered flag is displayed, it means the race is complete.

BLUE FLAG WITH YELLOW DIAGONAL

1. (Oval - Sno-Cross) For passing-flag will be displayed to snowmobiles being lapped.

SIGNAL LIGHT RULES

1. Sanctioning bodies, which employ signal lights, must inform competitors of their signal light protocol before the start of the event. When light signals are used instead of flags, all competitors must be made aware of signal light procedures prior to the race.
2. Competitors must obey signal lights.
3. The following signals apply to OVAL, ENDURO and other specified closed course races:
 - a. GREEN LIGHT-Start of race.
 - b. YELLOW LIGHT-Caution
 - c. RED LIGHT- Stop snowmobile. At the direction of the Race Director, return cautiously to the starting line.
4. The following signal lights apply to DRAG racing:
 - a. PRE-STAGE/STAGE-Flashing or non-flashing means stage snowmobiles, be

ready to race.

- b. YELLOW LIGHT-Staged and ready to race.
- c. GREEN LIGHT- Start of race
- d. RED LIGHT-Driver has left the line before green light.

TIMING

1. It is the driver's responsibility to see that his snowmobile triggers the scoring system properly.
2. Starting and finishing lights must be of a uniform height.

RACE STARTING PROCEDURES

1. All drivers must be assembled on the starting line, ready to race within two (2) minutes of notification of their race (except special events).
2. Another method may be: Pre-entry competitors will draw for start position in respective class first. Race day entries will draw for position behind pre-entry drivers at the time of sign-up.
3. Snowmobiles may be pushed to the starting line.
4. All participants (including crewmembers entering the start line area, are required to wear eye protection or safety glasses.
5. Snowmobiles must be placed on an approved stand for warm-up and/ or for clearing the track. See CLEANOUT/SAFETY STANDS in this chapter.
6. All snowmobiles on the starting line must have the track and both skis flat on the course surface, before starter begins the race.
7. All snowmobiles will be started from a standing position, in a line abreast (unless stated otherwise).
8. The driver's feet must be on the running boards or stirrups. The Race Director may disqualify a driver if the driver's method of start interferes with other contestants.

START

1. On a false start a racer will be penalized by the Chief Starter, Race Director or Flagman.
2. There shall be no change of drivers at any time without notification to the Race Director (except special events).
3. Events that take place under natural lighting will be terminated thirty (30) minutes after published sunset. This rule must be strictly enforced. Furthermore, this rule assumes that there are no other visibility issues other than sunset. If visibility is reduced beyond the prescribed limit by other factors, racing must be halted before the prescribed time.
4. Any conditions that reduce visibility (prior to 30 minutes after sunset) must be considered before continuing to race. Other conditions include (but not limited to) snow dust, ice dust, fog, haze, clouds, mist, falling snow, falling rain, and smoke.
5. It is the Race Director's responsibility to discontinue racing if the visibility falls below the prescribed level at any time during the day.
6. An injured or otherwise incapacitated driver or damaged snowmobile shall be prohibited from racing with exception that if in the Race Director's judgement, the

driver or snowmobile is determined not to be a danger to driver's self or any other competitor. The Race Director's decision is final.

RACE RESTART PROCEDURE

1. The Race Director may have a restart at his discretion. Race Director's decision is final.
2. In the event of an accident involving one (1) or more snowmobiles, the Tech Director may at his sole discretion rule said snowmobile(s) mechanically unsafe to participate in the restart. These snowmobile(s) must be fully safety inspected and approved by the Race/Tech Director before further competition will be permitted.
3. (Oval - Sno-Cross) All snowmobiles will be stopped under the red flag. The flagman will notify drivers when to move snowmobiles and he will have them proceed slowly to the point of restart. If only one (1) lap, or less, has been raced, the order of snowmobiles for the restart will be the same as the beginning of the race (with the following exceptions):
4. Any snowmobile causing the stop of a race and a subsequent restart will be placed to the rear of the restart sequence.
5. Any snowmobile unable to immediately return to the starting line will be placed to the rear of the restart sequence.
6. After more than one (1) lap has been raced, the restart position of the snowmobiles reverts to the last officially counted lap.
7. Snowmobiles will be restarted in a staggered line.
8. With the Race Director's permission, only one (1) crewmember (per snowmobile) will be allowed on the track in the event the competitor cannot start his/her snowmobile alone. No mechanical work can be performed by the crew member. He may assist the driver in starting the sled, by pulling the recoil device/rope, controlling throttle, applying choke/enrichener, or alternate fuel delivery squirt bottle, removing the hood, securing hood, and tether switch, handing safety and personal equipment to driver.
9. Drivers and snowmobiles must be on the starting line within two (2) minutes of restart notification.
10. (Oval Sprint) Under Red Flag conditions up to 3 pit crew members per sled are allowed on track to add slide lube and perform engine and radiator cooling functions to the sled.
11. Upon be summoned to restart, all crew members shall leave the track surface except the designated crew member who assists in the engine starting procedure with the driver.
12. (See #8 above)

LEAVING THE COURSE

1. Drivers should stay on the confines of the marked course. At the discretion of the Race Director, a driver may be disqualified for leaving the confines of the course.
2. (Oval - Sno-Cross - Cross Country) Drivers may not stop on the racecourse. If mechanical problems or other factors

require stopping, driver will comply with rules for the specific event as prescribed by the officials before the event.

CONTROL OF SNOWMOBILE DURING RACE

1. It is expressly forbidden to drive or push a snowmobile in a direction other than that of normal race traffic. A driver who has spun out is permitted to turn snowmobile around to continue the event provided such action is taken only when the course is clear.
2. (WaterCross) Loss of a buoy in oval classes may result in a disqualification for the heat or final being raced if the Flagman or Race Director determines that it has caused an unsafe condition.

BLOCKING AND FOOLISH DRIVING

1. The deliberate blocking of a faster snowmobile is cause for disqualification at the discretion of the Race Director.
2. Bumping or cutting of lanes is cause for penalty or disqualification at the discretion of the Race Director. Any dangerous or foolish driving, bumping crowding, chopping, cross jumping or unsportsmanlike conduct on the course, in the pit area, or anywhere else on the race grounds will subject contestant to disqualification at the discretion of the Race Director.

OBSTRUCTION

1. (Oval, Sno-Cross, Cross Country, Enduro) If for any reason a driver is forced to stop on or near the course during an event, it would be the driver's first duty to remove the snowmobile from the track so as not to endanger or obstruct other drivers.

RACE FINISH

1. The finish line will be clearly marked.
2. (Except for Speed Run) A driver whose snowmobile is disabled before driver reaches the finish line may be pushed or pulled by driver's own unaided muscular energy across the finish line and will be considered to have completed the race. A competitor is said to have finished the race when driver is in contact with the snowmobile and any part of the snowmobile crosses the finish line.
3. (Oval -Sno-Cross) All laps must be completed by first (1st) place snowmobile to declare a finish. All competitors will be given a finish position per number of laps completed. Any drivers that do not complete the checkered flag lap will be scored in order of finish and laps completed. Appropriate points and prize money will be awarded based upon published formulas.

SIGNALS

1. A driver who has spun off or stalled must raise both hands over driver's head to indicate that no more movement will be made until the field has passed and to indicate no injury.

DRIVERS BRIEFING

1. The mandatory meeting (or meetings) will be held at an announced time and place.

It will be conducted by the Race Director and Race Promoter. Descriptions of the course, flags, etc. will be made. An interpreter should be used when needed. Pins, stamps, tags, etc. may be used to check the identity of drivers at the briefing.

RADIOS

1. There will be no independent radio transmission on sanctioning body's radio frequency.
2. Unless otherwise stated, radio communication between crew and driver not allowed while driver is on the course. See specific sections for details.

CLEAN OUT / SAFETY STANDS

1. Snowmobile safety stands that catch and retain track, track lugs, traction components and other items that are thrown by a track are mandatory (see illustration).

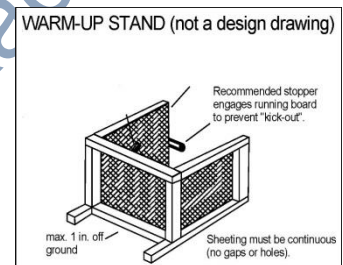

2. The stand must be no more than six (6) inches from the rear of the tunnel opening and no more than twelve (12) inches from the track. The safety stand will be constructed of metal equivalent to 6061/T6 aluminum, 1/8 inch thick. Side panels are mandatory, and they must extend at least to the center of the rear axle. Vertical coverage must be no more than one (1) inch off the ground/ice and as high as the snowmobile support device. Coverage must be continuous (no lightening holes). A plywood liner is recommended to help absorb impact. Safety stand must maintain sufficient height to prevent track encountering ground/ice surface. The stand must be used whenever the rear of a snowmobile is raised to clean out the engine or track.
3. (Drag Racing) Clean out will only be allowed at specified backboards. The snowmobile must be placed on a safety stand and the safety stand must be against the clean-out backboard. Backboard minimum requirements are eight (8) feet tall, four (4) feet horizontal space for each snowmobile. Backboards must be sheeted with 3/4-inch plywood (no chipboard). Additional clean out boards may be placed in the paddock area.
4. No full throttle operation while snowmobile is on warm up stand (recommendation). (See Hillclimb for Hillclimb version of jackstand equipment specs/photo.)

MISUSE OF PIT PASSES

1. Improper usage of pit or paddock passes will be grounds for discipline.

FIRE EXTINGUISHER

1. Fire extinguishers must be available in pit, paddock/staging and starting line areas. Fire extinguisher minimum size will be five (5) pounds with ABC fire extinguishing capabilities. Fire extinguishers will be in place before the start of the race.

GENERAL SNOWMOBILE RULES

These **GENERAL RULES** apply to all snowmobiles in competition unless so noted. All participants, racers and crewmembers are required to be fully aware of these regulations and must abide by them.

Participants are solely responsible for the condition of their snowmobiles and their competence to operate them.

Where the rules permit or require components or equipment to be installed, replaced, altered, modified or fabricated, it is the sole responsibility of the driver to select components, materials and/or fabricate the same so that the components will perform safely in competition.

CLASS ELIGIBILITY & SNOWMOBILE ID

1. Unless otherwise specified in specific ISR rules, a snowmobile used in more than one class or division must comply with all rules and safety guidelines for each class or division in which it competes.
2. In stock and stock-based classes, the chassis and engine must have been originally OEM assembled and serial numbered indicating that the snowmobile is a stock qualified unit from the production run of a stock qualified model.
3. All snowmobiles in Modified and Open classes must have serial numbers permanently affixed to the engine and the frame. Duplication of serial numbers is not allowed.
4. If the tunnel, engine or other serial numbered part is replaced, the serial number must be removed from the replaced part and affixed to the new part.

ENGINE

1. ISR and/or the Race Rules Committees will approve the validity of all engine intake systems.
2. In stock and stock-based classes, the engine must have originated from a stock qualified, OEM produced snowmobile.
3. In stock and stock-based classes, coolant thermostats, regardless of location in the cooling system, may be ran as produced, changed to alternate temperature settings, or completely removed. If removed a control plate/washer to control volume of flow may be installed in its place. This plate shall serve no other function than restricting the flow of coolant.
4. In Stock classes, the OEM for the model exhaust system must remain as produced

by the manufacturer and must be fully functional.

5. In modified drag racing and some other types of racing, the following minimum standards for straight-thru silencers are required:
 - a. Inner pipe must have at least 15 holes per square inch. Minimum hole size 1/16 in. (Minimum 3/8 in. sound absorbing material around the entire circumference of inner pipe).
 - b. Inner pipe (perforated core) must contact sound absorbing material (fiber or steel wool packing).
 - c. Outer pipe must be at least 3/4 in. larger than inner pipe.
 - d. Minimum silencer length 3 in.

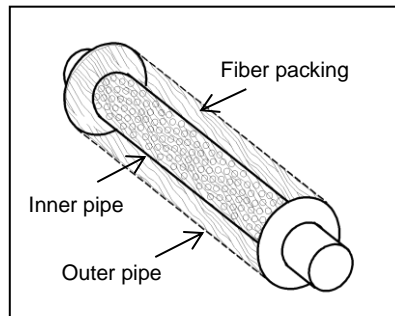

6. OEM carburetor slide valves and replacement jet components without modification will be allowed in all Stock classes. No modification to carburetor body will be allowed.
7. An adequate return spring on the throttle is required. The throttle must be a direct mechanical thumb mechanism, which must be located on the rear side (toward the rear of the snowmobile) of the right-hand handlebar. Throttle must be thumb operated. Twist grip throttles not allowed. **Water Cross** exception: Any hand operated throttle positioned on the right-hand side handle bar allowed. No twist grips allowed.
8. No pressure charging allowed unless specified.
9. All Stock classes - Choke control devices may be disconnected; however, they may not be removed from their mounting location.
10. When superchargers are allowed, a supercharger restraint system, including a flexible blanket shield, is required to prevent super chargers from being blown free of the engine.

DRIVE

1. Brakes shall be operative at all times. Brake lever must remain on the left, front side of handlebar.
2. The master cylinder, caliper and disk assembly must be commercially available.
3. Additional brake assemblies may be added. If the secondary brake is on the track drive shaft, the disk may be smaller than 7". Brake disk in any other location must be a minimum of seven (7) inches in diameter. Track drive shaft may be lengthened to accommodate additional brakes.

4. In Modified and Open classes, anytime the brake assembly has been modified or relocated, the brake disk must be covered with a shield capable of retaining an accidental explosion.
5. The disk pad contact surface area may not be reduced more than 15% of the original pad contact surface area.
6. Chains, pulleys and exposed moving parts will be isolated from the driver and other competitors by shields capable of retaining all accidental explosions and component impacts. Integrity of protective shields shall be at the Race and/or Tech Director's discretion. No holes may be drilled in protective shields.
7. Unless otherwise specified, stock class belt guards are acceptable in Stock classes only.
8. Secondary clutch windage plates may be removed in all classes. Windage plates may not be added in Stock based classes unless OEM for the model.
9. **Custom clutch guards, clutch guards on purpose-built chassis, and specialty chassis may use Carbon fiber, Kevlar, and other materials as reinforcement of standard clutch guard material and design. Newly designed clutch guards must exceed the specifications and limits established in standard clutch guard requirements, See specific disciplines for details. Each specific clutch guard must be submitted to ISR with digital pictures (both installed and uninstalled, at least four views) and a detailed explanation of design, design limitations, and method and type of fasteners used to affix the guard to the chassis. ISR may request an appointment to inspect on site.**
- 10.

SKI SUSPENSION AND STEERING

1. Handlebar extensions are allowed in some classes in some forms of racing. They must conform to the illustration below.

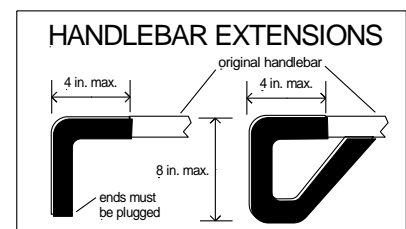

2. All handlebar ends must be plugged.
3. Only steel suspension springs allowed unless otherwise specified.
4. At safety inspection, ski suspension travel will be measured vertically at the front bumper.

SKIS & SKI RUNNERS

1. Except where otherwise specified, one cutting edge (steering edge) allowed per ski on snowmobiles with independent front suspension. Any ski edge with over 1/2-inch turn down constitutes a cutting edge. Hillclimb only: Ski's with over 1/2 inch *turn down on any edge will be allowed*. Multiple turn downs allowed.
2. A maximum of fourteen (14) inches total

length of carbide per ski is allowed (unless otherwise specified in specific chapters).

- All ski loops must be at least one (1) inch wide and 5/8-inch-thick or 1-inch diameter round material. The arc of the leading edge of the ski loop must have an outside radius of at least 2 1/8 inches and extend at least 120 degrees upward (see illustration). Plastic ski loops must be affixed with steel bolts.

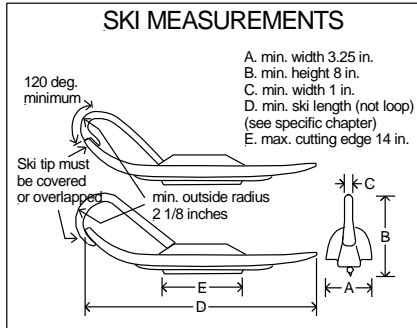

- The ski loop must overlap the end of the ski and secure to the under side or it must cover the leading edge of the ski entirely. (See Hillclimb specific rules for Hillclimb exemption.)
- Metal ski loops must be affixed with steel bolts and not welded (Oval-minimum two fasteners).
- Metal ski loops must have adequate lateral or vertical support bracing to prevent ski tip loops from dislodging or breaking off.

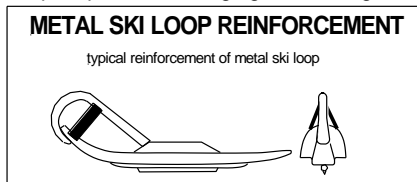

- Beam breaker surface for electronic timing must be confined within the ski loop (unpolished, flat black).
- (Oval, Enduro, Ice Lemans, Sno-Cross, Drag) Ski tip (not including the loop) must be turned up 1.5 inch from the bottom of the ski (not including the keel(s) or ski runner).
- No part of the ski may contact the body or suspension through the ski's normal range of travel and/or movement.

TRACK SUSPENSION

- Any OEM type slide rail hyfax may be used as a replacement.
- Slide rail hyfax can be drilled in all classes.
- Where allowed in these rules and by local environmental laws, slide rail lubrication systems may be used. No lubrication medium will be allowed that hampers competitor's visibility. No toxic solutions may be used.
- (Hillclimb Cross Country - Sno-Cross - Drag) Slide rail lubrication systems are not allowed. Slide rail inserts may be added.
- Only steel suspension springs allowed unless otherwise specified.
- At safety inspection, track suspension travel will be measured vertically at the

rear bumper.

TRACK & TRACTION

- Track dimension rules are specified in each chapter. A 1/8-inch maximum variance in the minimum track width requirement is allowed. No cutting, notching or trimming of the track is allowed, except as noted in specific sections.
- Unless otherwise indicated, the track must be centered on the centerline of the tunnel in all modified classes. Modified classes are allowed track offset for installation of brake assembly on front driveshaft. In no case may this offset be more than 2 (two) inches, determined from edge of track to inner edge (side) of tunnel. In Stock and Stock-based classes, the track location must be as produced unless otherwise specified.
- In all forms and classes of racing, track clips and guide clips may be replaced when worn - guide clips may be removed and replaced with track clips - track clips may be removed and replaced with guide clips - the track must retain the original number of clips with which it was produced.
- In all forms of racing, there are traction device limitations, see specific chapters for details (see Appendix for traction device measurement details).
- Identification numbers affixed or molded into tracks by the molder of the track must remain completely visible and unmodified. No traction device or other item may be installed over the identification numbers on the track. Identification numbers include model number, serial number and/or any other information applied to the track by the molder.
- Tracks may not be reversed.

FRAME & BODY

- A rear snow flap of sufficient material must be installed in a permanent manner and shall be held down (restrained from rearward movement) to restrain traction components, snow, mud, rocks and other material thrown from the track at all speeds. Recommended materials are 3/16-inch fiber reinforced rubber belting or 3/16-inch semi-rigid plastic such as HD polyethylene or UHMW polyethylene.
- The snow flap must overlap the widest part of the rear tunnel opening by at least one inch on each side.
- The rearward movement of the snow flap must be restrained with steel cable (or similar material) to the frame of the snowmobile. (Clarification: Exception, Hillclimb discipline sleds need not restrain the snowflap, but must meet all other snowflap dimension requirements.) The use of springs and/or elastic material for holding down and restraining snow flaps is not acceptable.
- The snow flap must be in contact with the course surface when the rider is on the snowmobile. Violation of this rule results in mandatory expulsion from the class.
- The snow flap on the twin track snowmobile must be reinforced to keep it in proper placement at racing speeds.

Two (2) separate flaps may be used on twin track snowmobiles.

- Material used in/as wheelie bars will not be considered a snow flap.
- The maximum overall snowmobile width is 45 inches unless otherwise stated.
- Except for Speed Runs and Hillclimb Modified and some Modified classes in drag racing, maximum snowmobile length is 120 inches.
- Where specifically allowed, foot stirrups/foot pegs may be installed. Must be constructed of rigid materials.
- All modified snowmobiles regardless of class or discipline will be equipped with an upholstered, padded seat minimum thickness one (1) inch, minimum length fifteen (15) inches. OEM seats may be cut down to the design needs of the builder but must meet these minimum standards.
- Unless otherwise stated, seats in Stock class must be OEM for the model. OEM seats have no requirements for fabric, padding, dimension, or coverage. If the seat meets manufacturers legal design criteria it is legal for any class, stock or modified.
- Unless otherwise specified, tunnel protective strips may be added to underside of tunnel to protect the tunnel and cooling system from being damaged by traction products.
- If a braking parachute is required, it must have been produced by a recognized manufacturer. Tech inspectors may observe the operation of the parachute and inspect for worn or frayed lines, ripped or dirty canopies and worn or ragged pilot chutes. Parachute cable housings must be mounted solidly to the frame or other suitable member; the use of quick pins for parachute mounting is prohibited. The parachute must be mounted in a manner that does not render it inoperative if the snowmobile should lose a track or part of the snowmobile (specifically, mounted above the snow flap and at the center of the rear of the tunnel). The parachute controls will be mounted so they are accessible to the participant in a normal driving position.**
- Parachutes are recommended on any snowmobile that can achieve 150 miles per hour and is mandatory for any snowmobile that runs 160 MPH or better.
- Snowmobiles used in competition may be painted any color with the following exception: In Sno-cross, Cross Country, Ice Lemans, Enduro and Oval racing, orange may not be used.

ENCLOSED COCKPIT FRAME & BODY

- A quick release seat belt/ shoulder harness (aircraft-type, automotive race type) is mandatory on all enclosed cockpit snowmobiles. All safety belts/shoulder harness installations must be mutually compatible (originally designed to be used with each other). Installations not allowed where the harness is sewn, fastened or where the safety belt is fed through the

loops in the harness. For harness installations see illustration. Only those units that release all four (or five) attach points in one motion are allowed. Shoulder harnesses must be securely mounted to the frame, cross member, or suitable reinforced mounting, and installed to limit driver's body travel both upward and forward. Belts and shoulder straps must be 3-inch minimum width.

- Quick release arm restraints are mandatory.
- Under no circumstances are bolts to be inserted through belt webbing for mounting.
- It is recommended that all belts and harnesses be covered with fireproof material.
- An abrasion plate is mandatory on seat belts where they are wrapped around the frame and would be exposed to rubbing on the track or by a rotating component.
- All enclosed cockpit snowmobiles must be equipped with a regulation on board fire extinguisher and must be manually controlled. The system must be halon 1301 or 1211 and mounted per manufacturer's specifications with the primary nozzle(s) directed to protect the participant while in the driving position. See OVAL OUTLAW rules for variations and exceptions.



- Fuel tanks must have a pressure cap and be vented to the outside of the body or have built in check valve.
- All roll cage structure must be designed to protect the participants from any angle, three hundred sixty (360) degrees. Flush grinding welds not permitted. It is recommended that all cage welds be gusseted. Must have a roll bar four (4) inches above driver's head (see illustration). An approved Fire-Retardant Suit, (fire suit) must be used and must be the final layer of clothing on the driver during competition. No other clothing may be worn over the firesuit.

OUTLAW 600

- OUTLAW 600 is not considered an enclosed cockpit class vehicle.
- All specific design and safety rules for Outlaw 600 are found in the class rule structure.
- An approved Fire-Retardant Suit, (fire suit) must be used and must be the final layer of clothing on the driver during competition. No other clothing may be worn over the fire suit.

IGNITION & ELECTRICAL

- All snowmobiles must be equipped with a tether switch that must be attached to the operator and be operable at all times. The switch must "kill" the engine by disconnecting the ignition system when the operator and the snowmobile become separated. It is the responsibility of the driver to make certain that the tether is attached to everyone who starts the engine or operates the snowmobile.
- Maximum tether cord length will be 4 feet except where noted otherwise. Verification of tether cord length will be determined at tether cord's fully extended length.
- The tether cord will be securely fastened to the driver. No alligator clips allowed.
- The tether switch will be securely mounted in a location on the snowmobile other than on the handlebars or steering column. Hillclimb only: The tether switch must be securely mounted to a structural component of the snowmobile and located in such a manner that it will not become detached from the snowmobile during accidents, or failed climbing attempts. In no way can the tether be fastened or restricted that would not allow it to function in case of need.
- (Drags, Speed Run, Sno-cross) All snowmobiles must have a handlebar mounted button (on/off) kill switch on the right side within thumb reach (this is in addition to your tether switch).
- Wet cell must be enclosed in a non-conductive battery box. Positive terminal must be shielded. Battery box must be securely held in place.
- On snowmobiles with enclosed cockpits it is mandatory to have a functional kill switch that will terminate ignition if the snowmobile rolls over, this is in addition to the tether switch.
- Unless otherwise specified, electric start parts including motor, solenoid, battery, battery bracket, wiring, and ring gear may be removed. No machining, cutting or grinding allowed for removal.

FUEL REGULATIONS

NOTICE: It is advisable for all competitors to have their fuel tested at the event, before competing.

- A contestant appealing a fuel disqualification must bear the expense of the fuel analysis and handling.
- Allowed gasoline and lubricants:
 - Only a commercially available pump gasoline that complies with these rules is allowed. (The term "pump gasoline" includes fuels dispensed from service station pumps and racing fuels that are commercially available in fuel cans and drums.) The gasoline may be mixed with petroleum, vegetable, or synthetic based lubricants. The use of oils, fuels (including gasohol), and additives that provide power-boosting characteristics are strictly forbidden.
 - Only motor fuel compounded of standard pump gasoline and an acceptable lubricant are allowed. Additives that produce power in excess of that produced by standard pump

- gasoline and petroleum base oil shall not be permitted. The list of unacceptable additives includes, but is not limited to, alcohol, nitrates, and other oxygen bearing compounds.
- No competitor or driver's pit personnel shall possess power boosting additives or agents upon the race premises of the sanctioned event. Violations of this rule shall subject the violator to severe disciplinary procedure.
 - Aerosol cans of ether are allowed at sanctioned races for starting purposes. No driver will be allowed to carry such cans on their person or their snowmobiles during the race.
 - Driver statements as to their fuel components will be binding and may be verified by various fuel tests. Drivers must allow officials to test their fuel at anytime.
 - In Stock Drag Racing and all Youth Racing classes, commercially available gasoline that is reformulated with up to 10% ethanol is allowed.

FUEL TESTS

WARNING: Gasoline, lubricants, additives and fuel test reagents are all potentially hazardous materials. Anyone handling them should be aware of the hazards and act accordingly. Race Rules Committees and ISR establish these guidelines and recommended test procedures, but do not assume liability for injury or death caused by the handling of these materials.

Any or all of these tests may be employed. Test results may be confirmed from time to time using an infrared spectrometer.

IF ANY OF THESE FIELD TEST ARE FAILED BY A PARTIAPANT HE WILL BE DQ'ED FROM ALL CLASSES THAT HE PARTICIPATED IN FOR THAT DAY.

ELECTRICAL CONDUCTIVITY

- CERIC NITRATE REAGENT TESTING
- REAGENT D TEST FOR DIOXANE
- WATER SOLUBILITY TESTING
- ANY OTHER TEST APPROVED BY RACE RULES COMMITTEES

ENFORCEMENT, DISCIPLINE AND VIOLATIONS

All participants are subject to disciplinary action for violations of these rules in accordance with the sanctioning organization's bylaws. Penalties may include suspensions, fines, loss of points, disqualifications or any combination thereof. The nature of the penalty is determined by the gravity of the offense and its effect on the safety and good reputation of snowmobile racing. The violations hereinafter set forth are subject to the penalties noted.

EJECTION FROM RACE SITE

- The Race Director has the right to eject

any person(s) from the pit, paddock (staging area) or racetrack area.

CONDUCT OF PARTICIPANT (OFFICIALS, DRIVERS, CREWS, ETC.)

1. Participants are solely responsible for the condition of their snowmobiles and their competence to operate them.
2. No driver may, at any time, ride/drive in such a manner as to endanger life or limb of other riders, officials or the public.
3. Vulgarity, derogatory or offensive language will result in disciplinary action, ejection from race site and be subject to fines and penalties.
4. Any participant that threatens bodily harm or assaults any official, driver, crew, etc. will be subject to disciplinary action, ejection from race site and be subject to fines and penalties.
5. Clothing displaying vulgar language is not allowed.

DRIVER LIABILITY, RELEASE COVENANT NOT TO SUE

1. ***The driver/pit crew, in filing an application to enter the event, elects to use the course of the event at driver's /pit crews own risk, and thereby releases the sanctioning organization together with their heirs, assigns, officers, representatives, agents, tech personal, employees, and members, sponsoring organization and owners of properties on which sanctioned events are to be held from all liability from injury to person, property and/or reputation from tech decisions that may be received by said entrant and from all claims of said injuries to the parties listed above growing out of, or caused by any construction or condition of the course over which the event is held and or piece of equipment that participant entered into competition.***
2. ***Drivers/pit crew and other participants further acknowledge and fully understand that there may also be other risks that are not known or foreseeable at this time, and the above and released persons cannot control these risks, nor have the released persons judged the participants' skill level or ability prior to allowing the participants to participate and consequently is not in a position to guarantee the participants' personal health or safety during the programs, events or activities. DRIVER/PIT CREW KNOWINGLY AND VOLUNTARILY ASSUMES ALL SUCH RISKS, BOTH KNOWN AND UNKNOWN, ANTICIPATED AND UNANTICIPATED, EVEN IF ARISING FROM THE NEGLIGENCE OF THE***

RELEASED PERSONS OR OTHERS, AND THE PARTICIPANTS ASSUME FULL RESPONSIBILITY AND LIABILITY FOR THE PARTICIPANTS' PARTICIPATION.

3. ***In consideration of permission and as a requirement of participation in sanctioned events, drivers, pit crew and other participants hereby covenant and agree not to sue the sanctioning organization, or its heirs, assigns, officers, representatives, agents, employees, and members, sponsoring organization and owners of properties on which sanctioned events are to be held, and further agree to fully release, indemnify and hold harmless those persons from any and all causes of action, demands, claims, and loss of injury to person or property or damages, of any nature whatsoever, whether the participation is supervised, unsupervised, however the injury is caused, including, but not limited to the negligence of any released persons.***

DRIVER RESPONSIBILITY

1. The driver has the responsibility for the actions of his crew. It is the driver's responsibility to see that all crewmembers are aware and abide by all rules and guidelines.
2. The condition of a snowmobile is the responsibility of the driver. A driver may be disciplined if driver's snowmobile is modified so as to defraud the officials or other competitors.

FRAUD, BRIBERY & ILLEGAL ASSISTANCE

1. In addition to non-compliance with any of the above regulations or rules, the following offenses shall be considered a breach of regulations subject to disqualification.
 - a. Bribing or attempting to bribe anyone connected with the race or accepting or offering to accept a bribe.
 - b. Competitor accepting any kind of assistance that aids in snowmobile operation during the race.
 - c. Any fraudulent proceedings or act of prejudicing the interest of the race generally.

INTOXICATING BEVERAGES & DRUGS

1. Drinking of intoxicating beverages is strictly forbidden by any participant. Anyone showing evidence of having used an intoxicating beverage must leave the premises (specifically pit, paddock (staging area), warm up area, tear down and race track) immediately and be subject to disciplinary action by the disciplinary committee. This shall be in effect through the final inspection of snowmobiles.
2. Possession or use of illegal drugs or drug substances, as defined below, is prohibited in any form, by any participant, on the race facility, or in any area considered to be used in the operation of

the race facility, such as parking lots or leased properties.

3. Illegal drugs are these substances defined and prohibited by state/provincial and/or federal law.
4. Any person found to be in possession or under the influence of an illegal drug or drug substance on race facility property, as defined above, or any person who is arrested by duly constituted authorities and charged with possession and/or use of illegal drugs or drug substance or any person who is formally charged by a court of law with illegal drug violations, shall be subject to suspension from competition and eviction from the race facility, and denial of further entry to the race facility for a period determined by the disciplinary committee.
5. Any participant who is formally charged by a court of law with an illegal drug violation, upon notification to the ISR Advisory Board, shall be suspended from all forms of participation at any ISR event until such time as the charges are fully adjudicated through the legal process. Any conviction of a formal drug charge by such will be prohibited from taking part in any ISR or affiliated event for a minimum period of three (3) years from date of conviction.
6. Any participant suspended for violation of these rules may be granted an appeal hearing by a board of officials designated by the ISR Advisory Board, provided the suspended participant requests such hearing in writing, within fourteen (14) calendar days of the date of suspension. It is the responsibility of the suspended party to make such a request if a hearing is desired.
7. The cost of convening the board of officials will be borne by the participant prior to the convening of the board.
8. A participant suspended for violation of these rules, EXCEPT IN THE CASE OF PERSONS CHARGED WITH SELLING DRUGS, may, as the result of a decision reached through the hearing process detailed above, be reinstated, if it is mutually agreed that the participant (at his own expense) will produce documentation from a physician licensed within the state or province, certifying that he or she is drug independent, as a result of random and periodical examinations and urinalysis testing made at the request of the ISR Advisory Board.
9. If a participant is using prescription drugs on advice of a physician, such use must be reported to the Race Director prior to the participant's entry into any ISR activities. Failure to notify will subject the participant to penalties as prescribed above.
10. A participant is any person taking part in any event sanctioned by or affiliated with International Snowmobile Racing, Inc., in any form, including but not restricted to drivers, snowmobile owners, mechanics, crew members, sponsors, track officials, pit area personnel, manufacturers and press representatives. All such persons shall be considered public figures that have by their own choice become involved in the snowmobile racing events, with the

full understanding that he or she must abide by the rules and regulations established and published by ISR. All participants are responsible for their personal conduct.

RACE DIRECTOR AUTHORITY

FINES AND PENALTIES

HILLCLIMB ONLY

1. The race director or Technical director may impose a fine instead of disqualification for rules infractions that are not safety related, or performance enhancing items.
 - A. \$100.00 first offense
 - B. \$250.00 second offense
 - C. \$500 third offense.

1. The Race Director and Technical Director will be certified by the sanctioning organization.
2. The Race Director shall be responsible for the conduct of the race. He shall have the right to make the final determination concerning all aspects of the race and the race facility, including design (these rules and regulations notwithstanding).
3. He shall have the voice of authority to discipline the participants for violation of the rules. Such discipline will be limited to disqualification of a participant and/or exclusion from an event.
4. Official race results shall be approved by the assigned Race Director and a signed copy will be returned to the promoter for announcement and distribution.
5. Race Director may not have vested interest in the outcome of an event over which he/she officiates. He/she may not officiate over a class in which he/she has a vested interest.
6. Race Directors may compete in events other than those in which they officiate.
7. The Race Director may cancel any race or the complete event for reasons of safety regarding competitors or spectators, and in such case shall determine the awards, if any. The Race Director may shorten the race for any reasons of safety but must give drivers adequate notice in advance.
8. A Race Director may judge the mechanical integrity of all timing equipment.
9. Only Drivers (no other participants) will have discussions with the Race Director about protests, and driving complaints, etc., and may approach the Director before the day's events, after an event, or at the direction of the Race Director.
10. The Race Director has the authority to judge the racing abilities of competitors and take appropriate action to insure the safety of the event.
11. The Race/Tech director shall have the authority to determine structural integrity.
12. The Technical Director shall carry and be responsible for the official specifications and certain instruments for measurements concerning verification and control of contestants' snowmobiles. The Technical Director may not officiate over a class in which he has a vested interest.
13. Technical equipment and specifications will not be used for any purpose other than the conduct of the sanctioned event.
14. Decisions of the Race/Tech Director may be reviewed by the board of the sanctioning body.
15. Decisions made at an event shall not be overturned without a formal appeal. Notice of the appeal process shall be given and a suitable period for all parties to prepare must be allowed.

NO EXPRESS OR IMPLIED WARRANTY OF SAFETY SHALL RESULT FROM PUBLICATION OF OR COMPLIANCE WITH THE RULES AND REGULATIONS IN THIS PUBLICATION. THEY ARE INTENDED AS A GUIDE FOR THE CONDUCT OF THE SPORT AND ARE IN NO WAY A GUARANTEE AGAINST INJURY OR DEATH TO SPECTATORS OR PARTICIPANTS.

ASPHALT DRAG RACING

The intent of these classes is to establish races in which all can compete at their level of personal and equipment ability. The class structure is organized in such a way as to enable as many snowmobiles as possible a place to successfully compete.

If class rules are not followed, the class name shall not be used and the class shall be run as a specialty class with ISR's prior approval.

CLASSES

- There are three Asphalt Drag Racing Divisions
 Stock (1000cc maximum)
 Pro Stock (1000cc maximum)
 Open Modified (1000 cc maximum)
- All Specialty Sanctions and Classes must be approved in writing by ISR prior to competition.

GENERAL COMPETITION AND SAFETY RULES

ENGINE

- Pressure charging and nitrous oxide are not allowed.

DRIVE

- Brakes must be OEM type. Any additional brake assemblies must be added to the track drive axle shaft. Axle shaft may be lengthened to accommodate any additional brake assemblies.

SKI SUSPENSION & STEERING

- Suspension must have a minimum of 2 inches remaining travel with the driver seated. Measurement is taken vertically at the front bumper. The driver is responsible for demonstrating suspension travel.
- Rod ends (heim joints) must be installed with flat washers to prevent bearing pull out (see illustration). The rod end must not bind.

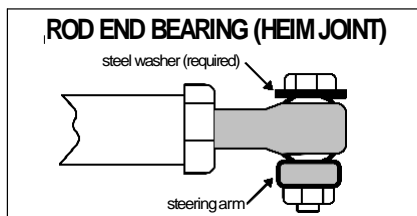

SKIS & SKI RUNNERS

- Skis must be OEM type steel or aftermarket skis specifically designed for use on pavement.
- Skis must be mounted so that "Trail" is greater than "lead" (see illustration). Minimum ski length 15 inches, maximum ski length 21 inches.

- Wheel wells may be cut in steel ski to accommodate wheels (see illustration).

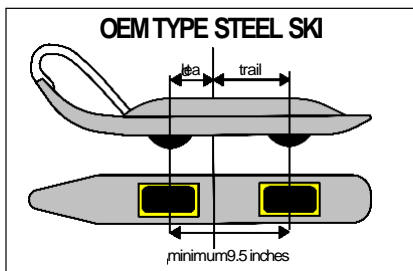

- Ski steering wheels must be specifically designed for snowmobile use on a dry surface.
- Steering wheels must be installed so that ski does not come in contact with course surface.

TRACK SUSPENSION

- No slide/track lubrication system allowed.
- Hyfax must be removed and a minimum of four (4) bogie wheels must be utilized on each slide rail (inside or outside) in a manner that prohibits the slide rails from coming in contact with the rubber track surface.
- Bogie wheels must be specifically designed for snowmobile use on a dry surface.
- Dual limiter straps are required on all chassis.
- Suspension must have a minimum of 2 inches remaining travel with the driver seated. Measurement is taken vertically at the front bumper. The driver is responsible for demonstrating suspension travel.

TRACK & TRACTION

- A flat configuration track ("slick track") is mandatory in all classes. Traction devices and rubber lugs are prohibited. Snowmobiles with elapsed times of less than 10 seconds (for the quarter mile) must use a track specifically designed for asphalt surfaces.
- Tracks must be designated for racing by the molder of the track.
- Track trimming or shaving prohibited.
- Track may not be reversed. Track must be run in the direction indicated by the manufacturer.
- Track must show no signs of excessive wear or damage.
- Track must remain stock (no soaking, treating or treading allowed.)

FRAME & BODY

- Pressurized containers must be stamped DOT-1800 pound rating and be securely mounted (no hose claps or tie wraps).
- OEM fuel tank mandatory. Additional fuel tank(s) prohibited. Oil injection tank may not be used as a fuel tank. Pressurized fuel tanks are prohibited.
- Rear snow flap must be secured to prevent it from being sucked into the track and fuel tank.

"W" shaped bracket attached to the upper rear of the tunnel.) Snow flap must be replaced if torn.

IGNITION AND ELECTRICAL

- No stutter boxes, delay boxes or delay devices allowed.

DRIVER RULES

- Participants will wear a one-piece leather suit (two piece suits must be securely fastened together with a zipper at the waist).
- Leather gloves are mandatory.
- Above ankle leather boots are mandatory.

STOCK CLASS RULES

GENERAL

- Unless otherwise stated herein, Stock rules in the Grass and Dirt Drag Racing Chapter apply.
- All snowmobiles must comply with the GENERAL RULES AND REGULATIONS section.

SKIS & SKI RUNNERS

- OEM type steel skis or aftermarket skis allowed. Skis must conform to General rules in this (Asphalt Racing) section.

TRACK SUSPENSION

- Must conform to Track Suspension rules in this (Asphalt Racing) section and to Stock Class rules in Grass and Dirt Drag Racing.

PRO STOCK RULES

GENERAL

- Unless otherwise stated herein, Pro Stock rules in the Grass and Dirt Drag Racing Chapter apply.
- All snowmobiles must comply with the GENERAL RULES AND REGULATIONS section.

SKIS & SKI RUNNERS

- OEM type steel skis or aftermarket skis allowed. Skis must conform to General rules in this (Asphalt Racing) section.

TRACK SUSPENSION

- Must conform to Track Suspension rules in this (Asphalt Racing) section and to Pro Stock Class rules in Grass and Dirt Drag Racing.

OPEN MODIFIED CLASS RULES

GENERAL

- Unless otherwise stated herein, Open Modified rules in the Grass and Dirt Drag Racing Chapter apply.
- All snowmobiles must comply with the GENERAL RULES AND REGULATIONS.

SKIS & SKI RUNNERS

1. OEM type steel skis or aftermarket skis allowed. Skis must conform to General rules in this (Asphalt Racing) section.

TRACK SUSPENSION

1. Must conform to Track Suspension rules in this (Asphalt Racing) section and to Open Modified Class rules in Grass and Dirt Drag Racing.